

Wi-Fi THERMOSTAT / CHRONOTHERMOSTAT

ENGLISH

Wall mounting



Installation and use manual

- Wireless connection
- Equipped with a back-lit LCD display with “White-LED” technology
- “All glass” finish for a pleasant and modern design
- Easy to program via APP
- Weekly programming

Serie: V002



Wi - Fi



230V
50/60 Hz



Programs
for day



Key lock



INDEX

	SIMPLIFIED EU DECLARATION OF CONFORMITY	pag. 2
	WARNINGS	pag. 3
	KEYS FUNCTION LEGEND	pag. 4
	DISPLAY LEGEND	pag. 5
	INSTALLATION	pag. 6
	ELECTRICAL CONNECTIONS	pag. 8
	FASTEN OR REMOVING THE THERMOSTAT FROM THE WALL BASE	pag. 10
	SYSTEM ASSEMBLY	pag. 11
	THERMOSTAT ASSOCIATION TO ROUTER	pag. 12
	THERMOSTAT OPERATION MODE	pag. 14
	OPERATIONS CARRIED OUT DIRECTLY BY THERMOSTAT	pag. 15
	THERMOSTAT TECHNICAL SPECIFICATIONS	pag. 16

EU SIMPLIFIED CONFORMITY DECLARATION

The manufacturer declares that the type of radio equipment listed below complies with Directive 2014/53/EU (RED).

The full text of the EU Declaration of Conformity is available at the Internet address shown on the label:

Manufacturer, Fabricat, Fabrikant, Fabbricante, Fabricante:

PERRY ELECTRIC S.r.l.

Via MILANESE, 11 - 22070 VENIANO (Como)

ITALY - www.perry.it

Tel. +39-031-8944.1 Fax +39-031-8365201

<http://www.perry.it/it/dichiarazioni.aspx>

Type, Typen, Tipo:

1TXCR029WIFI

Series, serie:

V002





WARNINGS



The installation and electrical connection of the programmable thermostat must be implemented only by a qualified electrician and in conformity with current laws and regulations.



Carefully read the instruction manual before using the product as it provides important guidelines regarding safety, installation and use. The instruction manual must be preserved with care for future reference.

- Ensure the product is intact once it is removed from its packaging.
- Packaging components (any plastic bags, PVC suspensions, etc.) must be kept out of reach of children.
- The programmable thermostat is not intended for use by persons (including children) with reduced physical, sensory or mental capabilities, or by those with a lack of experience and knowledge of the instructions, unless they are supervised or have received the necessary instructions concerning use of the device by a person responsible for their safety. Children should be supervised to ensure that they do not play with the device.
- If necessary, clean the programmable thermostat with a slightly damp cloth.



Important: for the system modes and operation of the Wi-Fi temperature control system and for correct installation, also see the specific manual of the APP.



Radio frequency waves emitted by the wireless programmable thermostat are not a risk to human or animal health.



INTERNET
offline

Important: the manufacturer shall not, under any circumstances, be liable if the products fail to operate due to the interruption of the internet network or unavailability of these resources: Cloud, Server, Portal.



Important: internet access costs are charged to users according to the rates of their mobile phone provider.



Important: the manufacturer reserves the right to introduce any technical and/or constructive changes deemed necessary, with no prior notice.

DISPOSAL OF ELECTRICAL & ELECTRONIC EQUIPMENT

This symbol on the product or its packaging indicates that this product shall not be treated as household waste.

Instead, it shall be handed over to the applicable collection point for the recycling of electrical and electronic equipment, such as for example:

- sales points, in case you buy a new and similar product;
- local collection points (waste collection centre, local recycling center, etc...).

By ensuring this product is disposed of correctly, you will help prevent potential negative consequence for the environment and human health, which could otherwise be caused by inappropriate waste handling of this product.

The recycling of materials will help to conserve natural resources. For more detailed information about recycling of this product, please contact your local city office, your household waste disposal service or the shop where you purchased the product.



KEYS FUNCTION LEGEND

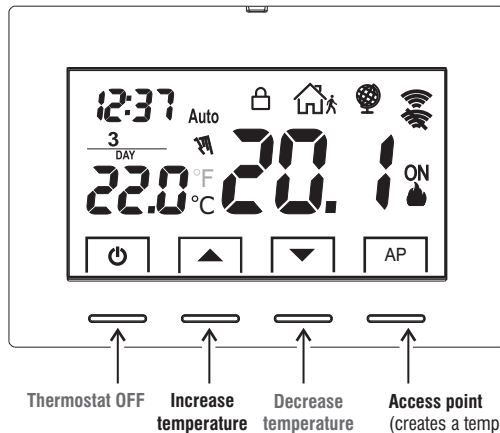

Important!

DISPLAY AND KEY BACK-LIGHTING



Touching any key activates back-lighting, displaying the words selection and navigation; press the desired key within 6 sec. to vary the settings (touching any key reactivates a 6 sec time-out).



Note: with fixed backlighting (which can be set from the APP); besides being always lit, the keys can be first touch operated

THE COLOUR OF THE KEYS varies depending on the temperature Set and operating at that moment, as per the rule below:

in WINTER 🔥 mode: Setting lower than 18,1°C = **keys lit in green**
Setting from 18,1 to 21°C = **keys lit in blue**
Setting over than 21°C = **keys lit in red**

in SUMMER ❄️ mode: Setting over than 26°C = **keys lit in green**
Setting from 26 to 23°C = **keys lit in blue**
Setting lower than 23°C = **keys lit in red**

DISPLAY LEGEND

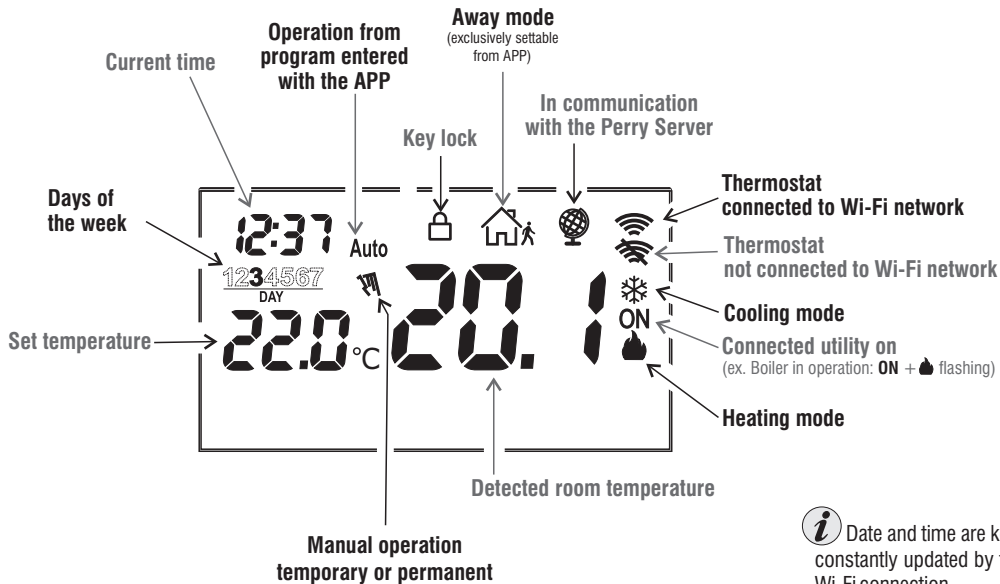

i Date and time are kept constantly updated by the Wi-Fi connection.

INSTALLATION

Radio range warnings

During installation, some precautions must be taken in order not to limit or inhibit the range of the radio waves between Wi-Fi Router and thermostat:

- install the appliance away from metal furniture or structures which could alter or screen propagation of radio signals;
- make sure that there are no electrical or electronic devices (television, microwave oven, etc.) within a range of at least 1 m from the appliance.

Note: if there are no obstacles between the thermostat and the Wi-Fi Router, the "open air" range is approximately 100 m; indoors with the presence of walls, the range is approximately 20m (see "technical data").

Radio range decreases significantly when the components are interposed between the obstacles. This attenuation varies in different degrees depending on the type of material the walls or barriers to cross are made of.

The presence of noise or electromagnetic interference sources can also reduce the indicated radio range.

Below are some examples of mitigation related to materials, which impact on the "Free air" range declared above.

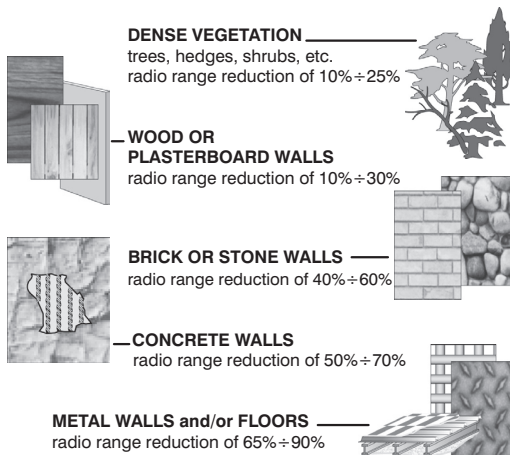

INSTALLATION

DIMENSIONS

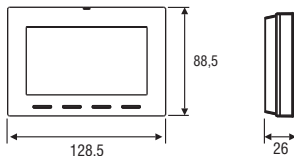

Thermostat installation: independent fixed

Wall mounted - onto a recessed rounded box or with a rectangular 3 module box.

INSTALLATION EXAMPLE

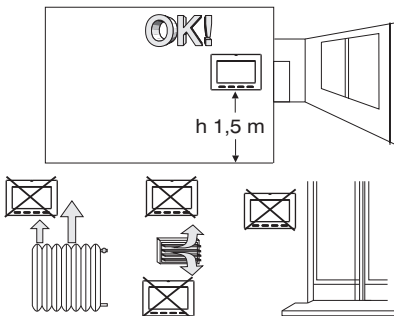

Install the thermostat preferably at a height of 1.50 to 1.60 m from the floor, far from sources of heat, air inlets, doors or windows and anything that may alter its operation.

FASTENING THE WALL BASE

- Switch off mains power 230V~
- Fasten the base of the thermostat with the screws supplied: to the wall, to the rounded or rectangular recessed box via the relative paired holes **A**.

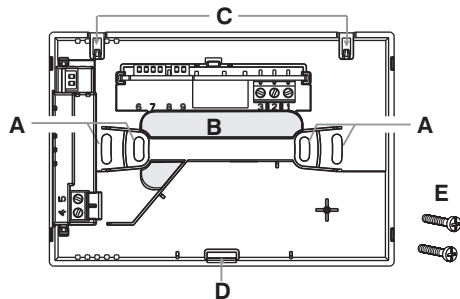

- A** - base fastening holes:
wall-mounted, round or rectangular recessed box
- B** - wire passage from corrugated tubes, round or rectangular recessed box
- C** - thermostat hooking teeth
- D** - thermostat fastening slot
- E** - screws to fasten the wall base to the rectangular or round recessed box.



To ensure the thermostat is fitted correctly to the wall-mounted base, the latter must not be bent due to the screws being tightened too much to the rounded or rectangular recessed box.

ELECTRICAL CONNECTIONS



Important: the installation and electrical connection of the thermostat must be implemented only by a qualified electrician and in conformity with current laws and regulations. The manufacturer declines all liability in connection with the use of products subject to special environmental and/or installation standards.



Attention!

Switch off mains power 230V~

230V~ power supply terminals

- Connect line voltage power supply to the terminals:
n° 4 - **LINE**
n° 5 - **NEUTRAL**

Relay terminals

- connect the device to be controlled to the terminals:
1 - common (C)
2 - normally closed contact (NC)
3 - normally open contact (NO)

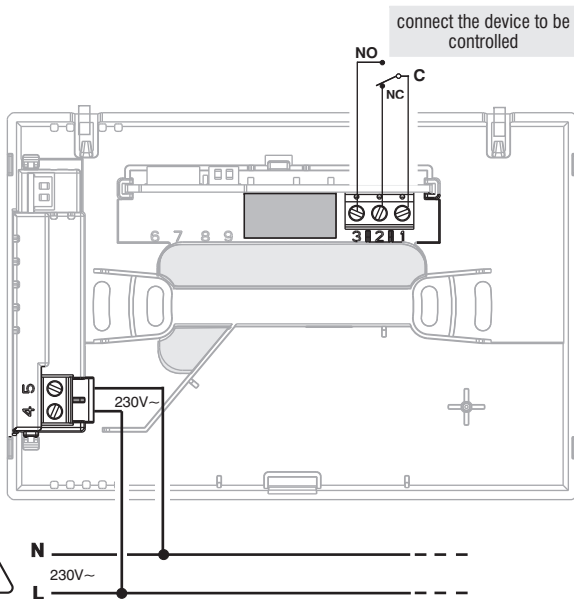

ELECTRICAL CONNECTIONS

Examples of electrical connections to devices to be controlled

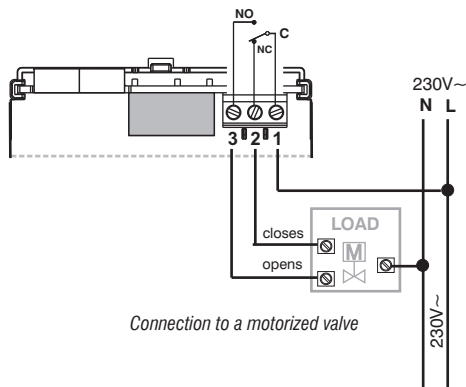
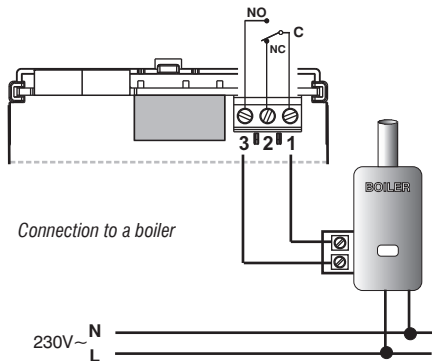

i with heavy inductive loads (pumps and solenoid valves), connecting an RC filter parallel to the load is recommendable.

After having completed the electrical connections, secure the body of the thermostat to the wall base as instructed in the following paragraph.

FASTEN OR REMOVE THE THERMOSTAT TO/FROM THE WALL-MOUNTED BASE

After having made the electrical connections:

- Apply the terminal cover to the base, securing it to hook **E**.
- To remove the cover, use a small screwdriver on hook **E** for leverage.

1°

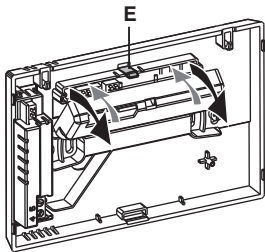

2°

Hook the thermostat to the wall base in teeth **C**. Then press the thermostat at the bottom to complete fastening in slot **D**. (CLICK indicating the correct fixing).

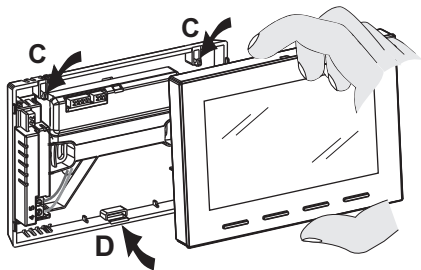

Removing the thermostat from the wall base



ATTENTION!
Disconnect the 230V~ mains voltage

3°

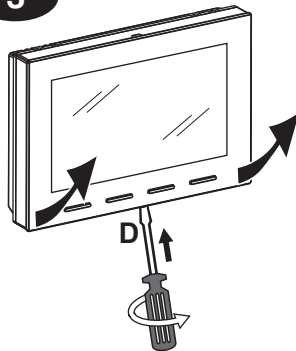

Unhook the thermostat from the wall base, using a screwdriver in the specific slot **D** in the lower part of the device for leverage, then turn to remove it.

SYSTEM ASSEMBLY

Note: if the device is not associated with a router with the appropriate APP, it will work as a simple thermostat.



IMPORTANT! The thermostat/chronothermostat can be used via the Perry APP with a Wi-Fi network connected to an internet network.

The device only supports Wi-Fi channels on the 2.4GHz frequency.

APP:  Perry Thermostat 230V
Perry Electric S.r.l.

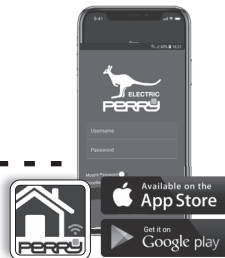
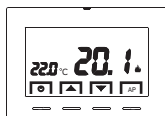

Docad the APP for free «**Perry Thermostat 230V**» from **Google Play** or from the **dall'App Store**.

APP manual,
also reachable through the use of the following QR Code:



Consult the APP manual, which is
available online at:

<http://perry.it/it/prodotto/1tx-cr029wifi.aspx>



IMPORTANT! The commands set via the APP may take a few minutes to be received by the thermostat depending on the internet network traffic.

THERMOSTAT ASSOCIATION TO ROUTER Wi-Fi

The programmable thermostat must be associated with the Wi-Fi network via the relative **Perry Thermostat 230V APP**.
After installing the **Perry Thermostat 230V APP** on your smartphone, register and log in.

assign a name to the house

assign a name to the thermostat

Press + as shown on the application screen

Enter the serial number of the thermostat is located on the bottom wall of the product consisting of 8 digits (exclude hyphen and last digit)

Associate it with your Wi-Fi Router

Enter your password

iOS

Android

Press any key to enable the keypad

Hold the AP key down for 5 sec.

Radio transmission screen, active for 5 minutes

The thermostat will generate a temporary Wi-Fi network identified by the serial number example: **PECR00000182**

To access this Wi-Fi network, you must enter a password example: **00000182**

Follows

The password is made up of the 8 digits present in the name of the network generated by the thermostat

THERMOSTAT ASSOCIATION TO ROUTER Wi-Fi

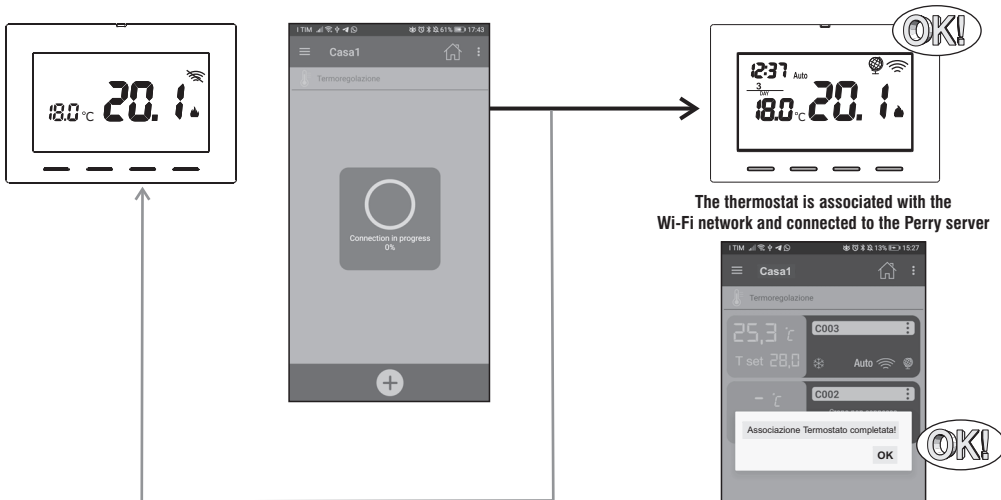

If no association occurs, repeat the above procedure.

Make sure the Wi-Fi network password has been entered correctly and the distance between the thermostat and the router does not exceed the declared limit.

The thermostat is associated with the Wi-Fi network and connected to the Perry server

Program and control the thermostat from the APP
(for more information see the APP manual)

THERMOSTAT OPERATION MODE

Auto: the set temperature changes automatically **depending on the program set via APP.**
(the set default temperature for all days of the week is 18°C).

Temporary override: this is a temporary mode activated when the temperature is modified directly by the user;
the change remains valid until the next programmed change.

OFF: the thermostat was switched off directly by the user;
it suspends all temperature control and can be remote-controlled.

TEMPORARY OVERRIDE mode

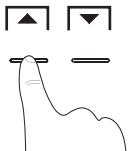

Temporary manual mode is activated by changing the set temperature. To do so, press the arrow keys ▲▼: the flashing symbol  appears on the display.

It will be active until the next change programmed by the APP or until midnight of the current day.

It is possible to exit in advance by pressing the key  twice or by using the command from the APP.



It is possible to set **Permanent manual mode** by only using the Perry APP. This way, the Set temperature can also be changed using the keys ▲▼ of the thermostat.

It is possible to exit the permanent manual mode from the APP as well as by pressing the key  of the thermostat twice.

OFF mode



Pressing the key  suspends (**OFF**) all temperature control, with the exception of the antifreeze/thermal protection functions, if activated.

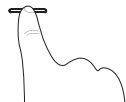

The thermostat can be remote controlled via APP.

Exit from the **OFF** mode by pressing the key  again or by using the command from the APP. The thermostat will go back to **Auto** mode.

OPERATIONS CARRIED OUT DIRECTLY BY THERMOSTAT

KEY LOCK

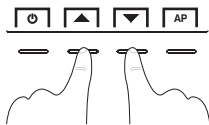

To lock the keyboard, simultaneously press the keys ▲▼: the lock symbol  will appear on the display (padlock).

To unlock the keyboard, simultaneously press the keys ▲▼: the lock symbol  will disappear from the display (padlock).



Operation that can also be carried out from the APP

RESET

Should the timer thermostat feature malfunctioning, wrong displays or other incorrect conditions, perform a **“Reset”**. Simultaneously press the  and **AP** keys. After a few seconds of Lamp-test, the thermostat will restart its normal operation.



RESET will not eliminate any settings saved on memory.

TECHNICAL SPECIFICATIONS

- Power supply 230V~ 50/60 Hz
- Backlit LCD with «White-LED» technology
- n°4 backlit keys (color blue, green or red depending on the set temperature band set), with lock option
- Type of action, disconnection and appliance: 1B / Electronic.
- Type of output: relay with contact in COM / NO / NC exchange, potential free - max 5(3)A/250V~
- Cross-section of the wires to the terminals: $0,5 \text{ mm}^2 + 2,5 \text{ mm}^2$
- Rated impulse voltage: 2,5 kV
- Software: class A
- Radio emission: the appliance intentionally emits radio waves at a frequency band of 2412-2472 MHz (Wi-Fi), with a max. power lower than 100 mW e.i.r.p.
- Integrated PCB aerial, indicated range 100 m outdoors, approximately 20 m indoors
- 72-hour charge (ensures current time advance)
- Non-volatile memory to store settings and programming carried out
- Temperature scale: °C (Celsius)
- **Weekly programming**, with 1 minute resolution, precision +/- 1 minute
- **10 programmable temperature levels a day**
- Set temperature: $+4 \text{ °C} + +37,7 \text{ °C}$, at $0,1 \text{ °C}$ steps
- Room temperature measurement: $0 \text{ °C} + +37,7 \text{ °C}$, resolution $0,1 \text{ °C}$, precision +/- 1 °C
- Operating temperature: $0 \text{ °C} + +45 \text{ °C}$
- Storage temperature: $-10 \text{ °C} + +60 \text{ °C}$
- Temperature control mode:
 - ON/OFF differential (default setting) Hysteresis settable from 0.2 °C to 1.2 °C at $0,1 \text{ °C}$ steps (default $0,3 \text{ °C}$)
 - PID modulating proportional settable from 7 to 20 minutes at 1 minute steps (default 7 minutes)
- Antifreeze mode (Winter) settable $+4 \text{ °C} + +12 \text{ °C}$ (default 5 °C)
- Thermal protection mode (Summer) settable $+37,7 \text{ °C} + +30 \text{ °C}$ (default in OFF - disabled)
- ERP Energy classification Reg. EU 811/2013:
 - in ON/OFF differential mode = ERP Class I 1%
 - in modulating proportional mode = ERP Class IV 2%
- Insulation class: Class II
- Protection rating: IP30
- Rate of pollution: 2
- Descaling function of the pump (it is activated for 2 minutes if it has never been activated in the previous 24h)
- Operating mode: Heating (default setting) / Cooling
- Thermal gradient: 1 °K every 15 minutes
- Temperature for marble test: terminals, printed circuit 125 °C ; enclosure 75 °C