

Wi-Fi PROGRAMMABLE THERMOSTAT

ENGLISH



Installation and use manual

- Wireless connection to the Smartbox
- Equipped with a back-lit LCD display with "White-LED" technology
- Easy to program via APP
- Weekly programming
- Battery powered (not included)
- "All glass" finish for a pleasant and modern design



The device only supports Wi-Fi channels on the 2.4 GHz frequency.

CONTENTS

 WARNINGS	pag. 3
KEYS	pag. 4
DISPLAY	pag. 5
INSTALLATION	pag. 6
ELECTRICAL CONNECTIONS	pag. 8
SECURING OR REMOVING THE PROGRAMMABLE THERMOSTAT FROM THE WALL BASE.....	pag. 9
BATTERIES FLAT OR ALMOST FLAT WARNING	pag. 10
INSERTING OR REPLACING BATTERIES	pag. 10
PROGRAMMABLE THERMOSTAT ASSOCIATION TO SMARTBOX	pag. 11
THE PROGRAMMABLE THERMOSTAT CAN OPERATE IN 3 DIFFERENT MODES.....	pag. 12
OPERATIONS CARRIED OUT DIRECTLY BY PROGRAMMABLE THERMOSTAT.....	pag. 13
PROGRAMMABLE THERMOSTAT TECHNICAL SPECIFICATIONS.....	pag. 14
SIMPLIFIED EU DECLARATION OF CONFORMITY	pag. 14

WARNINGS



The installation and electrical connection of the devices and appliances must be implemented by qualified personnel and in conformity with current laws and regulations.



Carefully read the instruction manual before using the product as it provides important guidelines regarding safety, installation and use. The instruction manual must be preserved with care for future reference.

- Ensure the product is intact once it is removed from its packaging.
- Packaging components (any plastic bags, PVC suspensions, etc.) must be kept out of reach of children.
- The programmable thermostat is not intended for use by persons (including children) with reduced physical, sensory or mental capabilities, or by those with a lack of experience and knowledge of the instructions, unless they are supervised or have received the necessary instructions concerning use of the device by a person responsible for their safety. Children should be supervised to ensure that they do not play with the device.
- If necessary, clean the programmable thermostat with a slightly damp cloth.



Important: for the system modes and operation of the Wi-Fi temperature control system and for correct installation, also see the specific manual of the smartbox and of the APP.



Radio frequency waves emitted by the wireless programmable thermostat are not a risk to human or animal health.



Important: the manufacturer shall not, under any circumstances, be liable if the products fail to operate due to the interruption of the internet network or unavailability of these resources: Cloud, Server, Portal.



Important: internet access costs are charged to users according to the rates of their mobile phone provider.



Important: the manufacturer reserves the right to introduce any technical and/or constructive changes deemed necessary, with no prior notice.

DISPOSAL OF ELECTRICAL & ELECTRONIC EQUIPMENT

This symbol on the product or its packaging indicates that this product shall not be treated as household waste.

Instead, it shall be handed over to the applicable collection point for the recycling of electrical and electronic equipment, such as for example:

- sales points, in case you buy a new and similar product;
- local collection points (waste collection centre, local recycling center, etc...).

By ensuring this product is disposed of correctly, you will help prevent potential negative consequence for the environment and human health, which could otherwise be caused by inappropriate waste handling of this product.

The recycling of materials will help to conserve natural resources. For more detailed information about recycling of this product, please contact your local city office, your house hold waste disposal service or the shop where you purchased the product.



KEYS

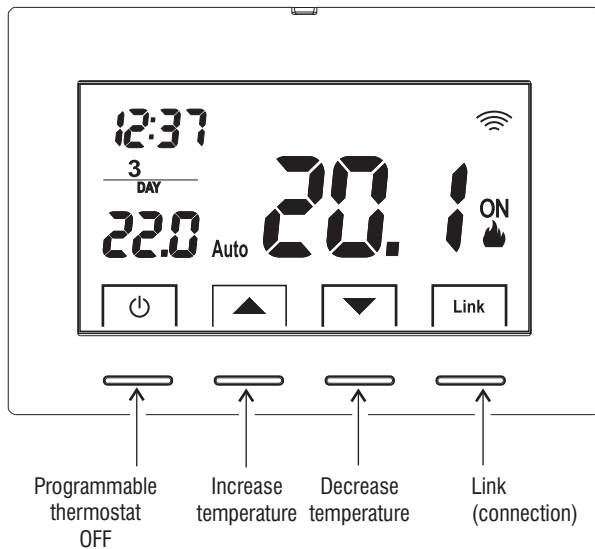

To activate the keyboard is necessary press any key (Keys and display backlight)



DISPLAY

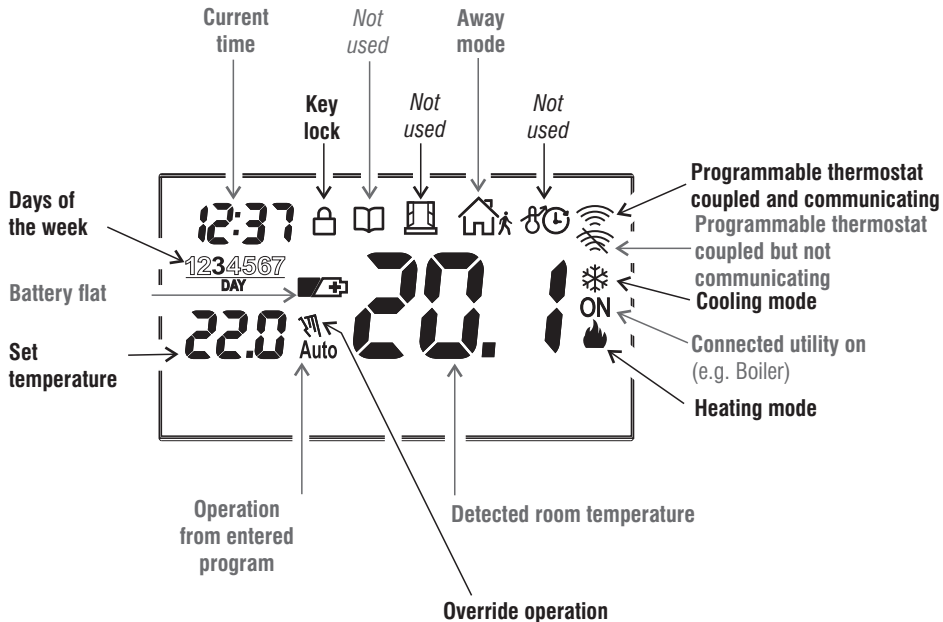

INSTALLATION

Radio range warnings

During installation, some precautions must be taken in order not to limit or, in some cases, inhibit the range of the radio waves between Smartbox and Programmable thermostat, in particular:

- install the appliance away from metal furniture or structures which could alter or screen propagation of radio signals;
- make sure that there are no electrical or electronic devices (television, microwave oven, etc.) within a range of at least 1 m from the appliance.

Note: if there are no obstacles between the Programmable thermostat and Smartbox, the "open air" range is approximately 200 m; indoors with the presence of walls, the range is approximately 30m (see "technical data").

Radio range decreases significantly when the components are interposed between the obstacles. This attenuation varies in different degrees depending on the type of material the walls or barriers to cross are made of.

The presence of noise or electromagnetic interference sources can also reduce the indicated radio range.

Below are some examples of mitigation related to materials, which impact on the "Free air" range declared above.

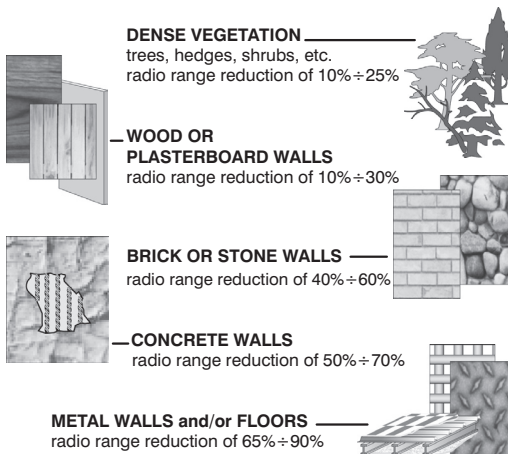

INSTALLATION

DIMENSIONS

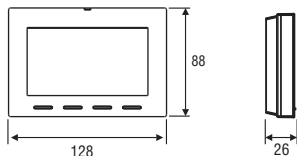

Programmable thermostat installation: independent fixed

Wall mounted - onto a recessed rounded box or with a rectangular 3 module box.

INSTALLATION EXAMPLE

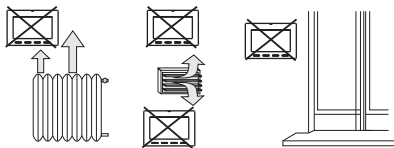
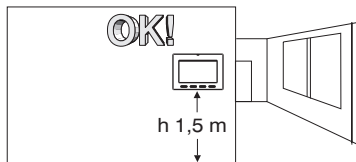

Install the programmable thermostat preferably at a height of 1.50 to 1.60 m from the floor, far from sources of heat, air inlets, doors or windows and anything that may alter its operation.

FASTENING THE WALL BASE

- Switch off mains power 230V~ to device
- Fasten the base of the programmable thermostat with the screws supplied: to the wall, to the rounded or rectangular recessed box via the relative paired holes A.

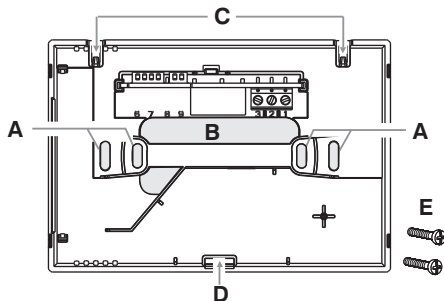

- A** - base fastening holes: wall-mounted, round or rectangular recessed box
- B** - wire passage from corrugated tubes, round or rectangular recessed box
- C** - programmable thermostat hooking teeth
- D** - programmable thermostat fastening slot
- E** - screws to fasten the wall base to the rectangular or round recessed box.



To ensure the programmable thermostat is fitted correctly to the wall-mounted base, the latter must not be bent due to the screws being tightened too much to the rounded or rectangular recessed box.

ELECTRICAL CONNECTIONS



Important: the installation and electrical connection of the devices and appliances must be implemented by qualified personnel and in conformity with current laws and regulations. The manufacturer declines all liability in connection with the use of products subject to special environmental and/or installation standards.

Relay terminals

- connect the device to be controlled to the terminals:
 - 1 - common (C)
 - 2 - normally closed contact (NC)
 - 3 - normally open contact (NO)



Disconnect the 230V~ mains voltage that powers the devices to be controlled

Examples of electrical connections

Connection to a boiler

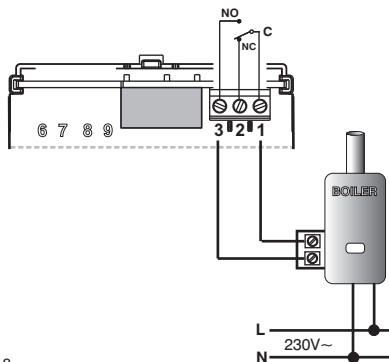

Connection to a motorized valve

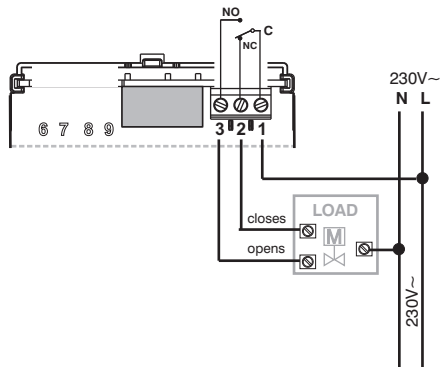

FASTEN OR REMOVE THE PROGRAMMABLE THERMOSTAT TO/FROM THE WALL-MOUNTED BASE

After having made the electrical connections:

- Apply the terminal cover to the base, securing it to hook **E**.
- To remove the cover, use a small screwdriver on hook **E** for leverage.

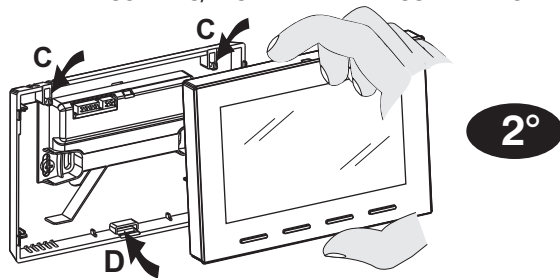
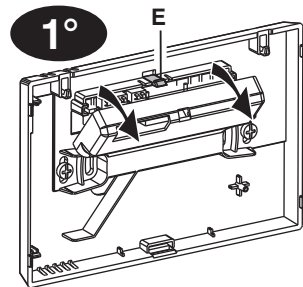

Hook the programmable thermostat to the wall base in teeth **C**.
Then press the programmable thermostat at the bottom to complete fastening in slot **D**.

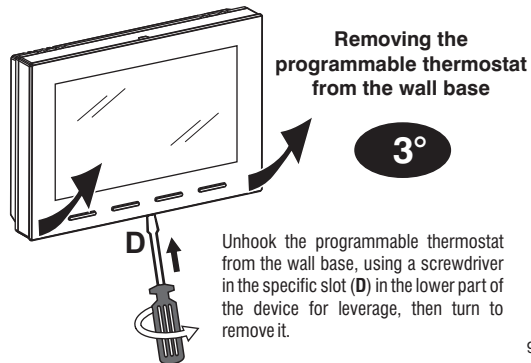

SIGNALLING BATTERIES LOW OR DOWN

When the  symbol blinks, this indicates that the batteries are running out and as from this moment there are 15 days to replace them.

Note: the backlight of the display is automatically deactivated.

If the discharged batteries are not replaced within this time the display will completely turn off.

All thermoregulation is suspended and all settings are saved to be restored when the new batteries are inserted.

INSERTING OR REPLACING BATTERIES

Unhook the programmable thermostat from the wall base (see previous paragraph)

Insert the batteries, respecting the polarity.

Hook and fix the programmable thermostat to the wall base (see previous paragraph)

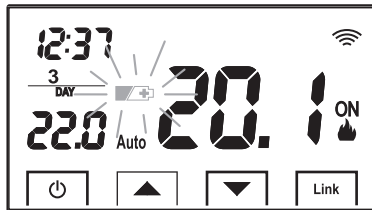
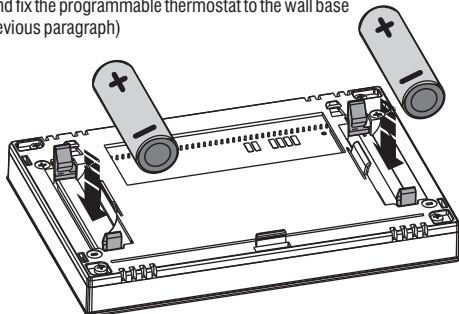

Attention: battery life may be more than 2 years. However, it is recommended to replace them at least every 24 months to avoid them running out when you are away (e.g. Christmas holidays, etc.)

ONLY USE GOOD QUALITY ALKALINE BATTERIES
(Duracell or Energizer batteries are recommended)

3V dc power supply
2 x 1,5Vdc LR6 - AA (not included)



Dispose of flat batteries in appropriate containers and as required by the environmental protection regulations.

PROGRAMMABLE THERMOSTAT ASSOCIATION TO SMARTBOX

The programmable thermostat must be coupled to the Smartbox with the specific PERRY PROGRAMMABLE THERMOSTAT APP. Instead of association via APP, you may associate the programmable thermostat by pressing the association key on the Smartbox for 3 seconds and the two external buttons (⏻+Link) on the programmable thermostat for 3 seconds.

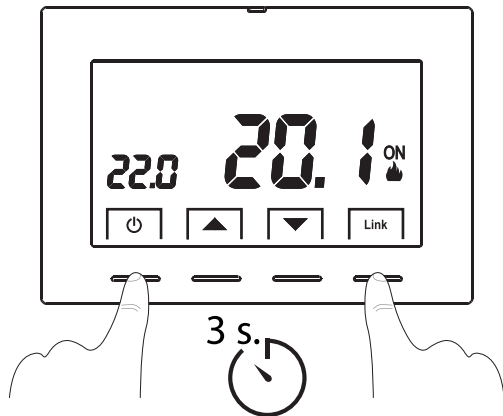
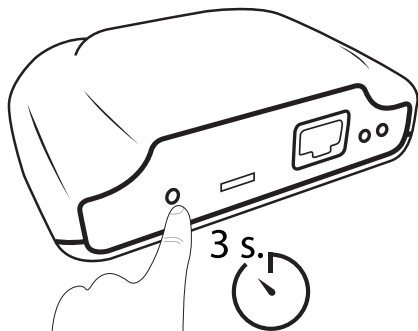

If no aerial symbol appears on the programmable thermostat, repeat the operation above.

If the aerial symbol  appears on the display of the programmable thermostat, it means that it has been associated correctly to the Smartbox.

If the symbol of the crossed-out aerial  appears on the display of the programmable thermostat, it means that it has been associated correctly but there are communication problems with the Smartbox. Make sure that the two devices are not too far apart or that there are no objects or walls significantly shielding the radio signal.

THE PROGRAMMABLE THERMOSTAT CAN OPERATE IN 3 DIFFERENT MODES:

Auto: the set temperature changes automatically depending on the program set via APP.

Override: this is a temporary mode activated when the temperature is modified directly by the user; the change remains valid until the next programmed change.

OFF: the programmable thermostat was switched off directly by the user, it suspends all temperature control and can be remote-controlled.

If the programmable thermostat is not associated to a Smartbox, it cannot operate in Auto mode.

Override mode:



by modifying the temperature using the arrows ▲▼ the override symbol  appears on the display.

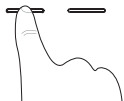

To exit the override mode, wait for the next programmed change, or press the key  twice.

OFF mode:



Pressing the key  suspends all temperature control, the programmable thermostat can be remote controlled via APP.





To exit the OFF mode, press  again and the programmable thermostat will go back to Auto mode.

OPERATIONS CARRIED OUT DIRECTLY BY PROGRAMMABLE THERMOSTAT

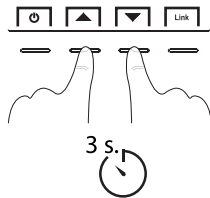
Key lock



To lock the keyboard, simultaneously press the keys ▲▼ for 3 seconds, and the lock symbol  will appear on the display.

To unlock the keyboard, simultaneously press the keys ▲▼ for 3 seconds, and the lock symbol  will disappear from the display.

Reset

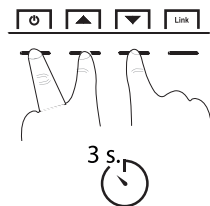

To restore the programmable thermostat to default conditions, perform the reset operation by simultaneously pressing the keys: ⏻ ▲▼ for 3 sec.

The text **RES** appears on the display. Press ⏻ to confirm the **reset**.

The programmable thermostat **loses association with the smartbox e and programming is cancelled.**

Note: the programmable thermostat will also be removed from the APP (see APP instructions)

Default settings:

- Programmable thermostat mode: OFF
- Set temperature: 18°C
- No RF radio connection (no association to smartbox)
- type: Heating
- Type of ON/OFF differential temperature control: Hysteresis 0.5°C
- Descaling pump: OFF
- Away OFFSET: 2°C

PROGRAMMABLE THERMOSTAT TECHNICAL SPECIFICATIONS

- Power supply by 2x **1.5V alkaline type AA batteries**, over 2 year duration
- LCD backlit
- 4 keys, with lock option
- Type of action, disconnection and appliance: 1 / BU / Electronic.
- Type of output: relay with contact in COM / NO / NC exchange, potential free - max 5(3)A/250V~
- Cross-section of the wires to the terminals: 1.5 mm² + 2.5 mm²
- Rated impulse voltage: 4 kV
- Software: class A
- Radio emission: the appliance intentionally emits radio waves at a frequency of 869,525 MHz, with a max. power 0.5mW e.r.p.
- Integrated PCB aerial, indicated range 200 m outdoors, approximately 30 m indoors
- Non-volatile memory to store settings
- Temperature scale: °C (Celsius)
- Weekly programming**, with 1 minute resolution, precision +/- 1 minute
- 10 programmable temperature levels a day
- Set temperature: 0 + 35 °C, at 0.5 °C steps
- Room temperature measurement: 0 + +50 °C, resolution 0.1 °C, precision +/- 0,5 °C
- Operating temperature: 0 + +45 °C
- Storage temperature: -10 °C + +60 °C
- Temperature control mode:
 - ON/OFF differential (default setting) Hysteresis settable at 0.2 °C / 0.4 °C / 0.8 °C / 1.6 °C
 - PID modulating proportional settable 10 minutes / 15 minutes / 20 minutes / 25 minutes / 30 minutes / 45 minutes / 60 minutes
- ERP Energy classification Reg. EU 811/2013:
 - in ON/OFF differential mode = ERP Class I 1%
 - in modulating proportional mode = ERP Class IV 2%
- Insulation class: Class II (pic.)
- Protection rating: IP30
- Rate of pollution: Normal
- Descaling pump (2 minutes to move the pump if not activated the week before)
- Operating mode: Heating (default setting) / Cooling
- Away OFFSET: 0.0 / 0.5 / 1.0 / 1.5 / 2.0 / 2.5 / 3.0 / 3.5 / 4.0 / 4.5 / 5.0 °C
- Temperature for marble test: terminals, printed circuit 125° C; enclosure 75° C



F.A.Q.

(Frequently Asked Questions and Inconsistent Resolutions)

consult the FAQ on page:

<http://perry.it/it/prodotto/1tx-cr028wifi.aspx>

or else access it using the QR code:



EU SIMPLIFIED CONFORMITY DECLARATION

The manufacturer declares that the type of radio equipment listed below complies with Directive 2014/53/EU (RED).

The full text of the EU Declaration of Conformity is available at the following Internet address:
<http://www.perry.it/it/dichiarazioni.aspx>

Manufacturer, Fabricat, Fabrikant, Fabricante, Fabricante:

PERRY ELECTRIC S.r.l.

Via Milanese, 11

22070 VENIANO (Como) - ITALY

Tel. +39 031.8944.1 Fax +39 031.8365201

www.perry.it

Type, Typen, Tipo:

1TXCR028WIFI V001

