

ASTRONOMICAL TIME SWITCH - NFC

Weekly - Menu-driven programming - Backlit display
1-channel model - 2-channels model

ENGLISH

 **NFC**

Available on the
App Store

Get it on
Google play



PERRY

APP: Perry Home



ASTRO



TIME



Art. 1104091NFC
Series: V001



Art. 1104291NFC
Series: V001



IMPORTANT:
Installation instructions,
programming and use
only from **KEYBOARD**

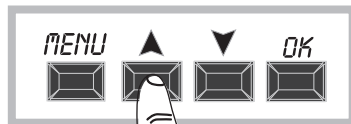

PERRY ELECTRIC Srl
Via Milanese, 11 - 22070 VENIANO (Como) ITALY



Dear Customer, thank you for choosing our product.

INDEX

INFORMATION AND SAFETY

PRECAUTIONS _____	pag. 3		
1 - Description of the unit _____	pag. 4		
1.1) Functional characteristics _____	pag. 4		
1.2) First battery insertion _____	pag. 5		
1.2.1) Low battery signal _____	pag. 5		
1.2.2) Replacing the flat battery _____	pag. 5		
1.3) Technical specifications _____	pag. 6		
1.4) Electrical connections _____	pag. 6		
1.5) Display _____	pag. 7		
1.6) Keys _____	pag. 7		
1.6.1) Specific key functions _____	pag. 8		
1.6.2) Shortcut keys _____	pag. 8		
1.6.3) Reset _____	pag. 8		
2 - First start-up _____	pag. 9		
2.1) Inserting the astronomical coordinates _____	pag. 11		
3 - Menu and programming _____	pag. 12		
3.1) Menu - overview _____	pag. 12		
3.2) Forcing and program priority _____	pag. 13		
3.3) Example of programs _____	pag. 13		
4 - «PROG» Menu (Programs) _____	pag. 14		
4.1) Creating a new program _____	pag. 14		
		4.1.1) «ASTRO / ASTRO» program type _____	pag. 15
		4.1.2) TIME / TIME program type _____	pag. 16
		4.1.2.a) Implementing a program lasting a few days _____	pag. 16
		4.1.3) Combining ASTRO-TIME programs _____	pag. 17
		4.1.3.a) Combination of ASTRO / TIME _____	pag. 17
		4.1.3.b) Combination of TIME / ASTRO programs _____	pag. 17
		4.2) Visualizing or modifying a program (ASTRO / TIME) already saved _____	pag. 17
		4.3) Copying a program _____	pag. 18
		5 - «HOLIDAY» program menu _____	pag. 19
		5.1) Creating a new HOLIDAY program _____	pag. 19
		5.2) Visualizing or modifying a HOLIDAY program already saved _____	pag. 20
		6 - Deleting a program _____	pag. 21
		7 - «OVERRIDE» menu _____	pag. 22
		8 - Menu «OPZIONI» _____	pag. 23
		8.1) Changing the language _____	pag. 23
		8.2) Setup _____	pag. 24
		8.3) Maintenance (MAINTENC) _____	pag. 24
		8.3.a) Managing a maintenance operation _____	pag. 25
		8.4) Hour counter _____	pag. 25
		8.5) Backlighting _____	pag. 26
		8.6) Warranty _____	pag. 26
		8.7) Info _____	pag. 27



IMPORTANT!

The instructions are unique for all models of the same series. The weekly 2-channel model with ± 1 h automatic daylight saving time adjustment is represented in the images below; certain parameters or symbols on the display will not be present when programming the daily 1-channel model without ± 1 h automatic daylight saving time adjustment.



INFORMATION AND SAFETY PRECAUTIONS

IMPORTANT! THIS INSTRUCTION BOOK EXCLUSIVELY CONCERNS PROGRAMMING AND USE VIA KEYBOARD. For the 1st COMMISSIONING OF THE DEVICE VIA APP, consult the manual included in the package.



It is advisable to read the installation and user instructions carefully and to keep them for future reference. The manufacturer reserves the right to make all the technical and construction changes it deems necessary without prior notice.



Important: the installation, electrical connection and commissioning of devices and equipment must be performed by qualified personnel and in compliance with regulations and applicable laws.



Before starting the installation and maintenance of the device, disconnect the 230V ~ mains power supply

- Do not connect or power the unit if any parts are visibly damaged.
- Once installation is complete, inaccessibility to the terminals without the use of special tools must be guaranteed.
- The manufacturer assumes no responsibility concerning the use of products that must comply with specific environmental and/or installation regulations.
- This unit must be intended only for the use for which it was built.
Any other use must be considered improper and dangerous.
- The device is supplied with a CR2032 lithium battery, keep the battery out of the reach of children.

NFC is a transceiver technology that provides short-range, two-way contactless wireless (RF) connectivity.

DISPOSING OF OLD ELECTRICAL AND ELECTRONIC EQUIPMENT



This symbol on the product or on its packaging indicates that this product cannot be treated as household waste. On the contrary, it must be taken to a specific collection centre for recycling electrical and electronic equipment, such as: - outlets, if a similar product to the one being disposed of is being purchased - local collection centres (waste collection centres, local recycling centres, etc.). By making sure the product is disposed of correctly, you will help prevent potential negative consequences for the environment and human health, which could otherwise be caused by inadequate disposal of this product. Recycling materials will help conserve natural resources. For more detailed information about recycling this product, please contact the local office in your area, the household waste disposal service in your area or the shop where you purchased this product.

1 - Description of the unit

ASTRO-TIME weekly digital NFC switches with 1 or 2 relay outputs (single or dual-channel) are equipped with a backlit display. The NFC interface allows communication with your smartphone and by downloading the free «Perry Home» APP it will be possible to carry out programming and settings directly on your smartphone in an easy and intuitive way, and then transfer all the data to the time switch /astronomical. The reverse procedure is also possible, i.e. copying the programming of a device onto your smartphone; alternatively, programming and use is always possible using the keyboard on the front panel **AS DESCRIBED IN THIS SPECIFIC MANUAL**. They represent the definitive solution to load management based on time or astronomical brightness and/or combinations of them; they are a synthesis of an ASTRONOMICAL SWITCH and TIME SWITCH in a single device, ideal for use in domestic, industrial buildings, schools, offices, public places, etc.

The backup battery allows you to maintain the settings even in the event of a blackout and can be replaced once exhausted.

DEVICES - 2 DIN modules

Art. 1104091NFC

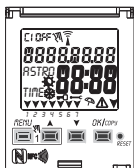

- Weekly model
- 1 channel
- Summer / Winter time change (± 1h auto)
- NFC interface

Art. 1104291NFC

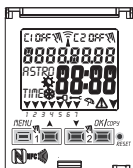

- Weekly model
- 2 channels
- Summer / Winter time change (± 1h auto)
- NFC interface

1.1) Functional characteristics and special features

- Device dimensions (LxDxH): 35 x 60 x 90 (2 DIN modules)
- Device with daily/weekly programming, guided by menus with the guidelines read on the white backlit display.
- Easy and intuitive programming and use via APP and NFC interface or via the keyboard on the front panel of the device (in questo caso scaricare le **AS DESCRIBED BELOW IN THIS SPECIFIC MANUAL**).
- Models with one or two relay control outputs.
- Calendar: year - month - day - hour and minutes.
- Date/time setting with automatic winter/summer time change.
- Multi-languages menu: Italian - English - German - French - Spanish.
- Memory capacity: 45 ON/OFF programs that are free to be set.
- Minimum ON/OFF 1-minute time scheduling to a maximum of 1 week less 1 minute.
- Types of programs: Astronomical (ASTRO) and Timer (TIME), Holiday (suspension of programs for a preset period of time)
- Possibility of entering 1 or more «Holiday programs», (suspension of Astro-Time programs) from a minimum of 1 day to a maximum of 12 months.
- Permanent memory for saving programs.
- Possibility of deleting the selected program rapidly.
- Program/s deletion menu.
- Possibility of permanent or temporary manual override (ON/OFF).
- Scheduled maintenance of the connected loads.
- Hour counter function to monitor the operating hours of the load.
- Warranty menu: view the elapsed time from when the product was connected.
- White backlit display.
- Managing the backlighting of the display: timed at 6 seconds / Fixed ON / Fixed OFF.
- Ecological LITHIUM battery, which can be replaced without removing the device from its seat.
- Charge reserve guaranteed by the lithium battery (replaceable) is about 4/5 years.
- Key lock.
- Hinged and sealable cover.

Note: a back panel with optional accessories KIT can be installed for all items.



1.2) FIRST BATTERY INSERTION

Open the battery door to the left ① and insert the battery into its housing with the **positive side facing up** ②.

Close the battery compartment door properly to the right ③.

Connect and activate the 230V power mains (see paragraph 1.4).

Set the required data as described in Chapter 2 - FIRST START-UP.

If the 230V ~ power mains is disconnected, the current date and time are kept updated by the backup battery (replaceable) with a power reserve of approximately 4/5 years.

The language, programs and all previously entered settings are saved in a permanent memory.

1.2.1) LOW BATTERY SIGNAL

When the battery reaches a minimum threshold level and there is a power cut, the display will show **bAtteErY** and the symbol  flashing for a few seconds. To review the message with the display off, briefly press the OK key.

1.2.2) REPLACING THE FLAT BATTERY

• Disconnect the 230V mains.

*Note: the display shows **bAtteErY** and the symbol .*

• Open the battery door to the left ① and insert the battery into its housing with the positive side facing up ②.

Close the battery compartment door properly to the right ③.

• Re-connect the 230V mains.

Note: the device will save all the previously set data in memory (with the exception of manual overrides).

The device displays the screen to select the language.



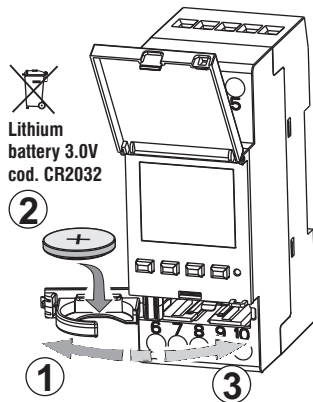

Press the OK button repeatedly to confirm all the settings saved in the memory until the normal operation main screen appears (display of the status of the channel/s, current date and time).



1.3) Technical specifications

Supply voltage	230 V c.a. +/- 10%
Frequency	50 Hz
Protection rating	IP20
Output type	Potential-free changeover contact relay; Contact range = 16(2)A / 250V~
Type of action, disconnection and unit	1 B S U / electronic
Section of the cables to the terminals	1...6mm ²
Replaceable backup battery	3V lithium code CR2032
Power reserve in case of power failure	about 6 years from the first start-up, guaranteed by the lithium battery (replaceable)
Rated impulse voltage	4kV
Software	A class
Operating accuracy	+/- 1 sec/day at 25 °C
Consumption/Stand-by consumption	8 VA mono-channel / 6 VA dual-channel
Type of insulation	II class <input type="checkbox"/>
Rate of pollution	2
Installation	DIN bar - back panel (with optional kit)
Operating temperature	from -20 °C to +55 °C
Storage temperature	from -30 °C to +60 °C
CE marking regulation	LVD/EMC EN60730-2-7
Languages available in the device	Italian, English, German, French, Spanish

Maximum controllable power

			
2300W	700W	290W (35 µF)	105W (max. 7 lamp. x 15W)

1.4) Electrical connections

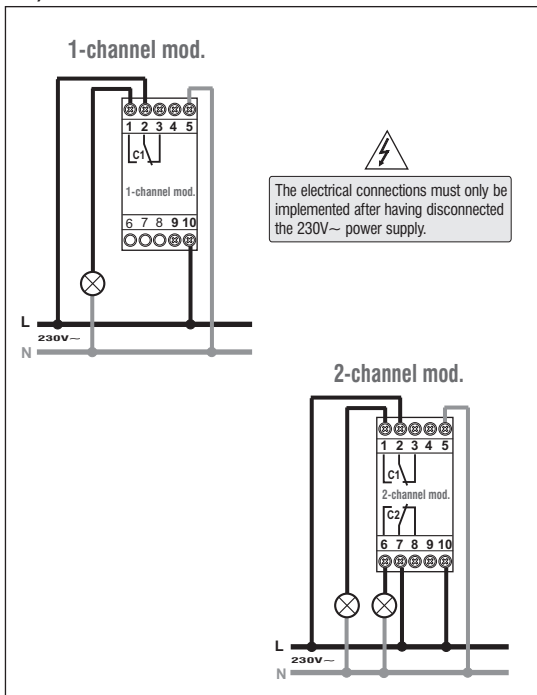

1.5) DISPLAY

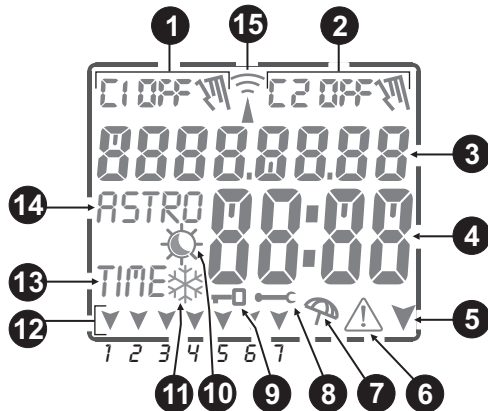

- 1** Channel 1 Field (status of relay 1)
- 2** Channel 2 Field (status of relay 2) *only dual-channel mod.*
- 3** Date / Text indication to browse or program
- 4** Hour and Minutes / Menu functions / Parameter values indication
- 5** Browsing arrow (menu or next sub-menu)
- 6** **ATTENTION!** icon
- 7** **Holiday** icon (suspension of programs in progress)
- 8** Icon for the set **Maintenance** of the connected load
- 9** "Keypad lock" icon
- 10** **Summer time** period icon ☀️ (summer changeover) and/or for **Astro** 🌙 **program**
- 11** **Winter time** period icon ❄️ (winter changeover)
- 12** **Day of the week** field
- 13** **Time programs setting** (TIME)
- 14** **Astronomical programs setting** (ASTRO)
- 15** Icon antenna: NFC attivo

1.6) KEYS

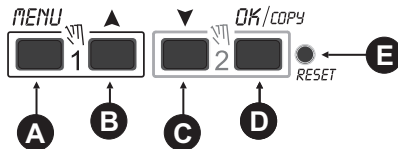

- A** **Access / Exit** the menus and sub-menus
- B** Scroll list **upwards** / **increase the value**
- C** Scroll list **downwards** / **decrease the value**
- D** **Confirm setting** / copy program
- E** **Reset** (no setting entered is deleted - para. 1.6.3)

Note: further details concerning the key functions are described in the specific paragraphs of use.

1.6.1) Specific key functions

Any of the functions described below are carried out from the **main screen**

Function	Press the key combination
Lock / unlock keys ()	2 seconds
Access the «Manual» menu directly to enable/disable the temporary or permanent override (see Chapter 7).	 for channel 1 for channel 2
With the ASTRO function activated you can view the following consecutively: - SUNSET / SUNRISE Time as at today - return to the «Main screen»	Press the key
	 pulse key

1.6.2) Shortcut keys

Function	Press key/s
Immediate exit from the menu or sub-menu	 2 sec. until the main screen appears
in the Programs menu, access the first free program that is to be set	 2 seconds
in the Programs menu, quickly deletes the selected program	 press simultaneously for at least 2 seconds

1.6.3) RESET

Reset reboots the time switch and is used in the event of unusual displays or malfunctions. Gently pressing the Reset button with a pointed object the time switch performs a lamp-test, thereby switching on all the segments of the display and then viewing the screen on which the language is selected. Implementing a Reset will lose the keypad lock and any activated manual overrides. All settings are retained: current date and time, programs, data concerning maintenance, hour counter and the warranty.

Reactivate the device from the language selection screen by **pressing the OK button repeatedly** to confirm all the settings saved in the memory until the normal operation main screen appears (display of the status of the channel/s, current date and time).

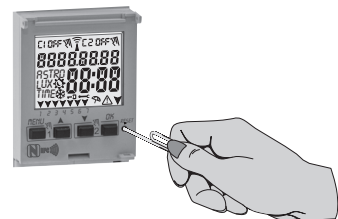

IMPORTANT: when programming, the settings made with the keys must be confirmed by pressing the OK key, and when OKAY appears on the display for a few seconds, it indicates that the data have been entered correctly in the permanent memory. Otherwise, after 2 minutes (10 minutes for «program» and «hour counter» settings), the digital switch returns to the "Normal operation" main screen and the partial changes will not be saved.



2 - FIRST START-UP (language selection, entry of current year, month, day, hour and minutes, summer/winter time setting)

The unit is supplied with default settings. After inserting the battery (see paragraph 1.2) and connecting the power supply, the unit resets the display (lamp-test) and then proceed as follows:

Select/set the data by pressing the ▲▼ keys and press the OK key to confirm and move on to the next field.

- Select the desired language.
- Set the current year, month and day.
- Set the current hour and minutes (keep the ▲ or ▼ keys pressed for the counter to advance rapidly).

The display shows **OKAY** for a few seconds and then displays the screen for the winter/summer time to be set.

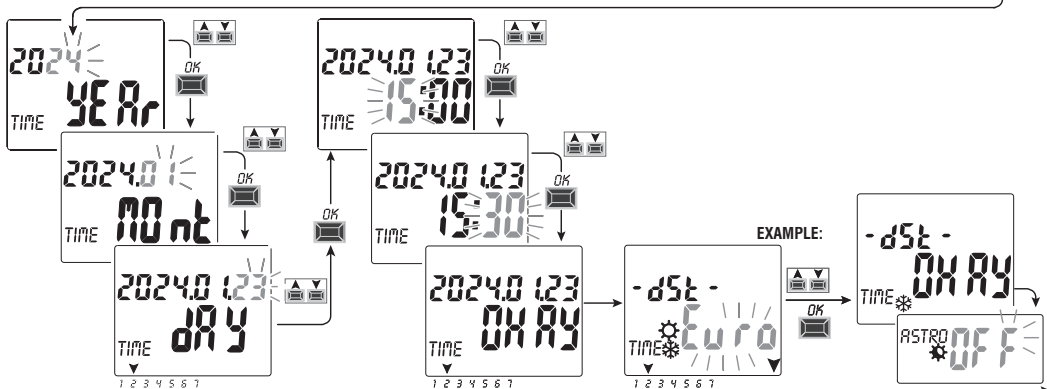

Set the summer or winter time. Select whith the ▲▼ keys between **EURO - FREE** (must be programmed) - **NONE** and confirm with **OK**.

Possible selections on the display	Summer changeover +1h (☀ summer time)	Winter changeover -1h (❄ winter time)
EURO = Central Europe UTC+1 (default)	Last Sunday in March	Last Sunday in October
FrEE	Month / Week / Day / Time freely programmable	Month / Week / Day / Time freely programmable
nOnE	None	None

- Set the astronomical coordinates.

By setting them, you move on to enter the **ASTRO ON** astronomical coordinates (see the procedure in the next paragraph 2.1).

By confirming «**ASTRO OFF**» with **OK**, **OKAY** appears and it moves on to the next item (Enabling the twilight sensor).

*If **ASTRO OFF** is confirmed, the astronomical coordinates can then be entered in two ways:*

- when an **ASTRO** program is first entered (see paragraph 4.1.1);
- entering the **OPTION > SETUP > ASTRO/SET** menu (see paragraph 8.2).

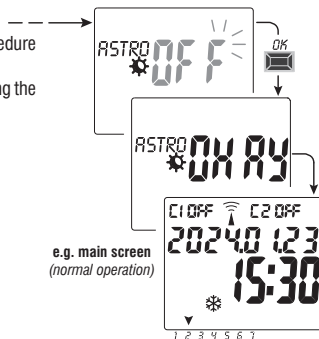

In the event of a power failure, (e.g. "black-out"), the digital switch:

- disables the relay/s;
- disables the twilight probe if connected and activated;
- switches off the backlighting, if activated;
- displays the flashing date and time for a few seconds, then switches to **stand-by** mode (display off). By pressing any key (except the key ▼), the device is activated for a few sec. When the mains voltage is restored, the device returns to normal operation, keeping in memory all the data programmed previously.

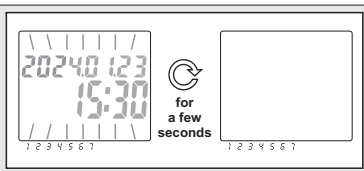

2.1) Inserting the astronomical coordinates (ASTRO activation)

for the ASTRO programs to work properly it is important to set some information to be entered (ASTRONOMICAL PARAMETERS), which allow the device to identify the geographic area where it will be installed.

- The display of the digital switch shows **ASTRO OFF**: select **ON** with the keys $\blacktriangle \blacktriangledown$.

Confirm with **OK**.

- The astronomical coordinates are then entered.

The operation consists of entering the latitude and longitude degrees (only integers) of the place of installation of the device. These data can be obtained from any atlas, Smartphone or GPS system.

By default the unit indicates the coordinates of Milan (Italy) Lat. North 45° Lon. East 9° time zone +1

- **Latitude** = use the $\blacktriangle \blacktriangledown$ keys to enter the latitude in degrees from **-60° (Lat SOUTH)** to **64° (Lat NORTH)**.

Confirm with **OK**.

- **Longitude** = use the keys $\blacktriangle \blacktriangledown$ to enter the longitude in degrees from **-180° (Lon WEST)** to **180° (Lon EAST)**.

Confirm with **OK**.

- **Time zone** = use the $\blacktriangle \blacktriangledown$ keys to set the time zone (in \pm 1h steps): **-14:00 ÷ 14:00**;

(this parameter represents the hours that shift from the zero line of Greenwich). Confirm with **OK**.

- **OFFSET** (offset correction) = you can set the switch-on at sunset and/or switch-off at sunrise for installation requirements (e.g. if the unit is installed in the shade of obstacles: mountains, condominiums, etc.), the following intervention can be corrected by using the $\blacktriangle \blacktriangledown$ keys:

-120 minutes ÷ 120 minutes at sunrise (☀ icon) by default the value is set at 0 (zero).

-120 minutes ÷ 120 minutes at sunset (🌙 icon) by default the value is set at 0 (zero).

Confirm with **OK**, **OKAY** appears on the display for a few seconds.

Press 2 times the **Menu** key to exit and display the main screen.

VIEWING SUNRISE-SUNSET TIMES (para. 1.6.1)

Press the **OK** pulse key on the main screen to verify the sunrise and sunset times as at today.

note: the displayed time considers the entered sunrise and sunset correction parameters

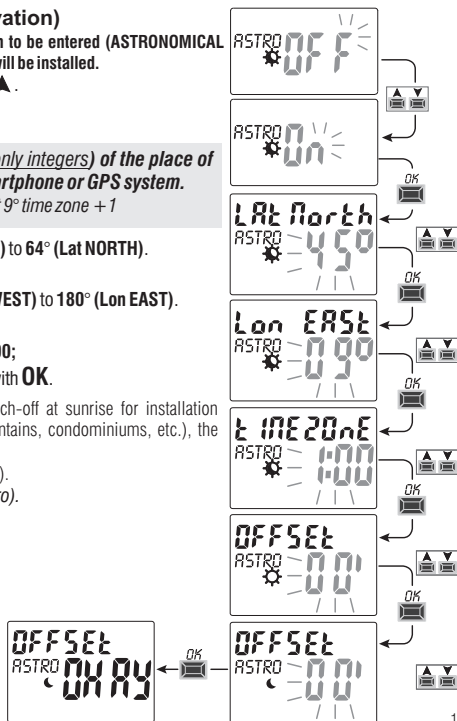

3 - MENU AND PROGRAMMING

3.1) Menu - overview

5 menus are listed in the sequence present in the unit:

1) PROG (Programs)

- Number of free programs
- Selection of no. of programs
- Selection of channel (only dual-channel) - Selection of day
- Selection of the (ASTRO or TIME) **ON** type of program (start-up) data entry according to the type of program selected
- Selection of the (ASTRO or TIME) **OFF** type of program (switch-off) data entry according to the type of program selected

2) ERASE PG (Program deletion)

- Deleting a single program
- Deleting all the programs

3) HOLIDAY

- Number of free programs
- Selection of no. of programs
- Selection of channel (only dual-channel)
- Setting - **MONTH – DAY OFF**
- Setting - **MONTH – DAY ON**

4) OVERRIDE (relay override)

- Selection of channel (only dual-channel)
- **AUTO**
- **ON PERM** permanent manual
- **OFF PERM** permanent manual
- **ON TEMP** temporary manual
- **OFF TEMP** temporary manual

5) OPTION

- Language selection
- ASTRO or TIME settings
- Maintenance
- Hour counter
- LED light (backlighting)
- Warranty
- Info

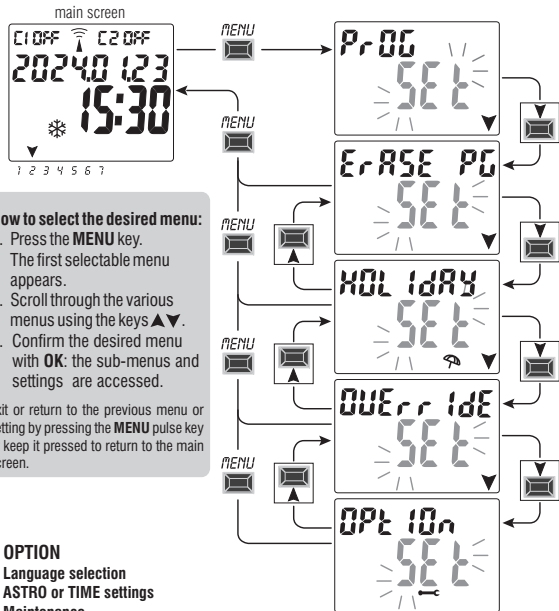

3.2) Forcing and program priority

A priority is assigned for each type of program/function as shown below on the right.
The output relay/s will be activated according to the set priorities.

IMPORTANT: all programs (ASTRO-TIME) entered are simultaneously active regardless of their position; in the case of overlapping commands on the same output, this is activated or remains so if at least one program is commanding it (OR LOGIC).

3.3) Example of programs

P01 programma di tipo **ASTRO / ASTRO**:

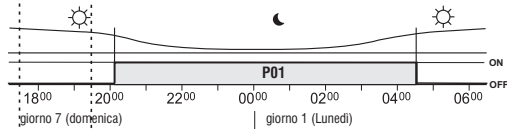

P03 programma di tipo temporale **TIME / TIME**:

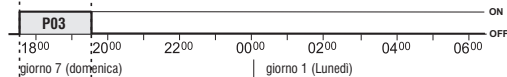

Nota: i programmi P01 e P03, essendo impostati allo stesso giorno, risultano contemporaneamente attivi.

MAXIMUM PRIORITY

**Permanent or temporary
manual override**

“Holiday” programs

ASTRO-TIME programs
(astronomical, time or combined)

i You can set the «COMBINED» programs starting with an ON type of program (example: ASTRO) and ending with OFF with another type (example: TIME).

4 - «PROG» menu (Programs)

This menu allows you to **create, test, modify, copy and delete** the programs (ASTRO / TIME).

4.1) CREATING A NEW PROGRAM

-  **Procedure valid for all types of programs.**
Additional settings are described in the individual programs.

1. Press the **MENU** key to access the first menu (**PROG SET**). Confirm with **OK**.
The number of free programs will be displayed for about 2 seconds, then the first program **P01** will appear flashing. If no text (ASTRO, TIME) appears on the left of the program it means that the program is free.
2. Select the desired program using the **▲▼** keys. Confirm with **OK**.

- **If there are several stored programs, keep the ▲ key pressed for 2 seconds to display the first free program that is to be set.**
- **Press the keys ▲▼ simultaneously for 2 seconds to rapidly delete the selected program.**

-  **If Holiday programs are saved, they are not displayed in this menu.**

3. Use **▲▼** keys to select channel C 1 or C 2 or both (only for the dual-channel model). Confirm with **OK**.
 4. Use the **▲▼** keys to select the day when the program must start (by default: 1 = monday).
The arrow indicates the selected day (example 7 = Sunday). Confirm with **OK**.
- The ASTRO ON program type is suggested by default.*
5. Use the **▲▼** keys to select the **ON** program type (ASTRO or TIME)

and proceed with the settings according to the type of program selected: ASTRO para. 4.1.1; TIME para. 4.1.2.

Note: you can select different types of programs for ON and OFF in the same program.
«COMBINED programs» starting with an ON type of program (example: ASTRO) and ending with OFF with another type (example: TIME).

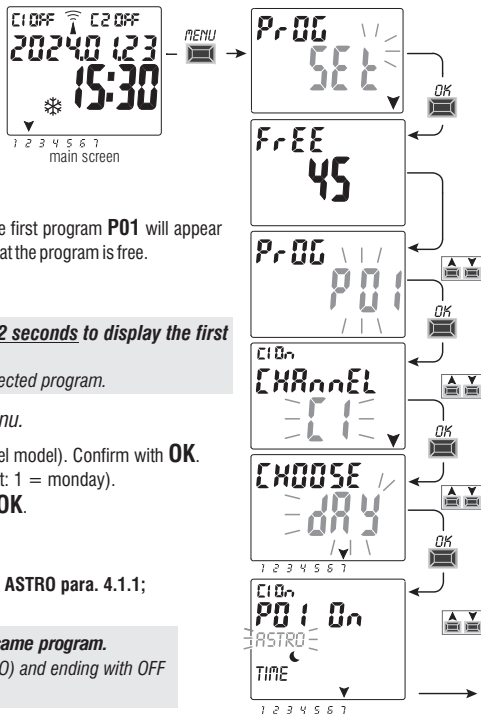

4.1.1) ASTRO / ASTRO program type

Useful for the management of electric utilities in relation to sunset and sunrise in the set geographical area, without external sensors.

After having selected the program number, the channel (only for the dual-channel model) and the day as described in para. 4.1:

1. Select the **ON** type of program with the keys **▼▲**.

(the **ASTRO** type is suggested by default). Confirm **ASTRO** with the **OK** key.

If the display shows  this indicates that the astronomical coordinates have not yet been activated/set; proceed as described in paragraph 2.1 to activate them.

2. Select the **OFF** type of program with the **▼▲** keys. Confirm **ASTRO** with the **OK** key.

3. After entering the program, the display first shows **OKAY**, and immediately after the number of free programs left and then the last set program.

Set a new program or press the **MENU** key 2 times to exit: the display will show the main screen (normal operation).

IMPORTANT! For **Copy** a saved program on other days, see the procedure in the paragraph 4.3.

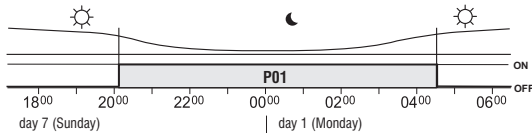

Example **P01 ASTRO/ASTRO**: type of program: sunset and sunrise interventions are computed by an astronomical algorithm based on the set coordinates and the local time.

The program begins at sunset (ASTRO ON) and ends at astronomical sunrise the next day (ASTRO OFF).

i The time of sunrise and sunset is calculated by considering the type of "Official" twilight and corresponds with the Zenith at 90°50'. Correspondence with the actual time of sunrise and sunset of a particular location also depends on changes in the weather, altitude and topography of the place, therefore, the calculated values must usually be corrected with the following parameters:
SUNSET TIME CORRECTION - SUNRISE TIME CORRECTION (see paragraph 2.1)

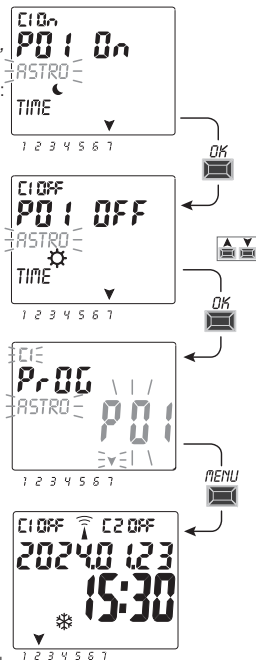

4.1.2) TIME/TIME type of program

Allows a load to start-up (time ON) and switch-off (time OFF) in a defined period of time.

After having selected the program number, the channel (only for the dual-channel model) and the day as described in the procedure in paragraph 4.1:

1. On the request to select the **ON** type of program (ASTRO is suggested by default), select TIME with the ▲▼ keys. Confirm with **OK**.
2. Use the ▲▼ keys to enter the start-up time (ON). Confirm with **OK**.
3. Use the ▲▼ keys to enter the minutes. Confirm with **OK**.
4. Select the **OFF**, type of program and use the ▲▼ keys to select **TIME**. Confirm with **OK**.
5. Use the ▲▼ keys to enter the switch-off time (OFF). Confirm with **OK**.
6. Use the ▲▼ keys to enter the minutes. Confirm with **OK**.

The display first shows **OKAY** and immediately after the number of free programs left and then the last set program. Set a new program or press 2 time the **MENU** key to exit. The display shows the main screen (normal operation).

IMPORTANT! For **Copy** a saved program on other days, see the procedure in the paragraph 4.3.

Example: P 03 TIME/TIME time type of program day 7 (Sunday) start-up ON at 17:45 - switch-off OFF at 19:30

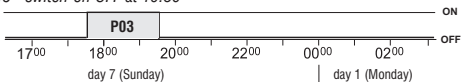

4.1.2.a) Implementing a program lasting a few days

If the ▲ key is pressed beyond 00:00 while setting the switch-off time OFF, the program will end on the day after activation; the arrow corresponding to the day after start-up will flash.

Scrolling the hours up to 00:00 once again will set the program active for two days, etc.; the two arrows corresponding to the two days after start-up will flash. If you press the ▼



key and a switch-off time earlier than start-up is set, the program will remain active throughout the week; all the arrows corresponding to the days will flash.

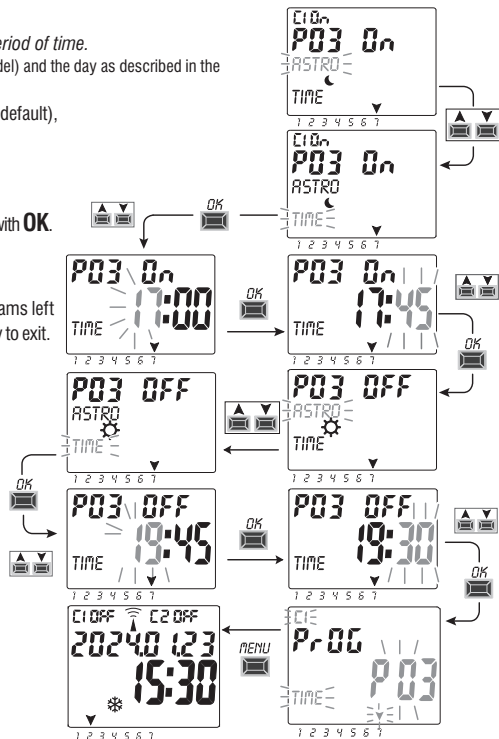

4.1.3) Combining ASTRO-TIME programs

You can also set the combined programs according to the specific requirements, starting with a type of program (example: ASTRO) and ending with another type (example: TIME).

- «**standard**» programs: ASTRO / ASTRO - TIME / TIME

- «**combined**» programs: ASTRO / TIME - TIME / ASTRO

Follow the same procedure described in paragraph 4.1 to enter a desired combined program.

4.1.3.a) Combination of ASTRO / TIME

Combination of ASTRO / TIME programs You can set the programs that start at astronomical sunset (ASTRO ON) and end at a fixed time (TIME OFF).

NOTE: when creating the ASTRO / TIME program, 23:59 is suggested as TIME OFF (editable) on the selected day.

- A program ends on the same day if the TIME OFF setting is before midnight

example: program start-up (ASTRO ON) at astronomical sunset e.g. at 18:30 and ends (TIME OFF) at 22:30 on the same day.

NOTE: the TIME OFF switch-off time must be after the ASTRO ON time (otherwise the program is not valid and is not implemented).

- A program ends the next day if the TIME OFF is set after midnight

example: program start-up (ASTRO ON) at astronomical sunset e.g. at 18:30 and ends (TIME OFF) at 06:30 the next day.

NOTE: TIME OFF switch-off time cannot be after 11:59 the next day.

4.1.3.b) Combination of TIME / ASTRO programs

You can set the programs that start at a fixed time (TIME ON) and end at an astronomical sunrise (ASTRO OFF).

- A program ends on the same day if the TIME ON setting is before midday

example: program start-up (TIME ON) at 05:30 and ends (ASTRO OFF) at astronomical sunrise on the same day e.g. at 06:30.

NOTE: the TIME ON start-up time must be before the ASTRO OFF time (otherwise the program is not valid and is not implemented).

- A program ends the next day if the TIME ON setting is after midday

example: program start-up (TIME ON) at 22:30 and ends (ASTRO OFF) at astronomical sunrise the next day e.g. at 06:30.

4.2) Visualizing or modifying a program (ASTRO / TIME) already saved

You can view or edit a previously saved program as follows (or as described in Chap. 4.1):

1. Press the **MENU** key on the main menu (normal operation) to access the first menu (**PROG SET**). Confirm with **OK**.

2. Select the program that is to be viewed or modified using the **▲▼** keys. Confirm with **OK**.

Press the **OK** key consecutively for the settings to appear again and reconfirm them. Change a setting by using the **▲▼** keys and confirm with the **OK** key.

View or edit all the settings until **OKAY** appears for a few seconds.

Exit the **PROG SET** menu by pressing the **MENU** key twice.

4.3) Copying a program

Copy a saved program (ASTRO / TIME / COMBINED) on other days of the week, as follows:

 If you are already in the programs menu and the saved program to load is displayed, proceed from point 3.

1. Press the **MENU** key to access the first menu (**PROG SET**).
Confirm with **OK**.
The number of free programs will be displayed for about 2 seconds, then the first program **P01** will appear flashing.
2. Select the program that is to be copied using the **▲▼** keys.
3. **Press the OK key for 3 seconds:** first appears ---- and immediately after **COPY Pr**
4. The display shows the day of the program that is to be copied (example: Sunday) and suggests the rest of the days of the week and **ON** flashing.
In this condition, the program would be copied for every day of the week, if confirmed by pressing the **OK** key for 3 seconds
5. If you want to exclude a few days, press the **▲▼** keys to select it, press **OK** to switch to **OFF**. The arrow corresponding to the selected day will go off.
6. Once you have selected the days that the program is to be copied to, **press the OK key for 3 seconds**. The unit copies and the display shows **OKAY** for a few seconds and then displays the last copied program.
Exit and return to the main menu by pressing the **MENU** key twice.

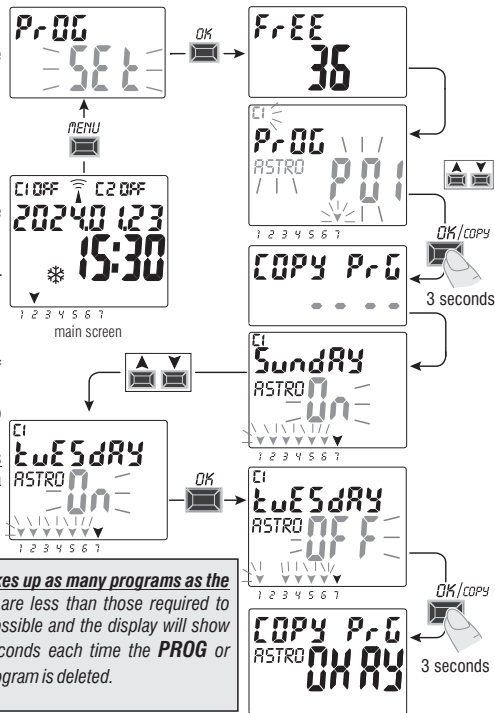

FULL MEM

1 2 3 4 5 6 7
e.g. display for a few seconds

IMPORTANT: when a program is copied, **the unit takes up as many programs as the selected days of the week**. If the free programs are less than those required to complete the copy, the unit will only copy those possible and the display will show **FULL MEM**. This will be displayed for a few seconds each time the **PROG** or **HOLIDAY** menus are accessed until some saved program is deleted.

5 - «HOLIDAY» program menu

This menu allows you to create, test, modify and delete the «HOLIDAY» programs.

The holiday programs allow you to set different periods during the year when to suspend the on/off programs combined with channel 1 and/or 2 (dual-channel mod.), example for Christmas and summer shutdown of a public or sales department.

5.1) Creating a new HOLIDAY program

1. Press the **MENU** key: the first menu is accessed (**PROG SET**).

2. Use the **▲▼** keys to select the **HOLIDAY SET**. Confirm with **OK**.

The number of free programs will be displayed for about 2 seconds, then the first free program will appear flashing if no Holiday program has been entered in the device (example: **P06**).

Use the **▲▼** keys to select the desired free Holiday program. Confirm with **OK**.

• **If there are one or more Holiday programs saved, the display shows the first Holiday program entered; press the **▲** key for 2 seconds to rapidly move to a free Holiday program that is to be set.**

• **Press the **▲▼** keys simultaneously for 2 seconds to rapidly delete the selected program.**

3. Use the **▲▼** keys to select channel **C1** or **C2** or **both** (only for the dual-channel model).

Confirm with **OK**.

4. Use the **▲▼** keys to select the month when program suspension is to begin

(OFF) (the number of the month flashes). Confirm with **OK**.

5. Use the **▲▼** keys to select the day when program suspension is to

begin (OFF) (the number of the day flashes). Confirm with **OK**.

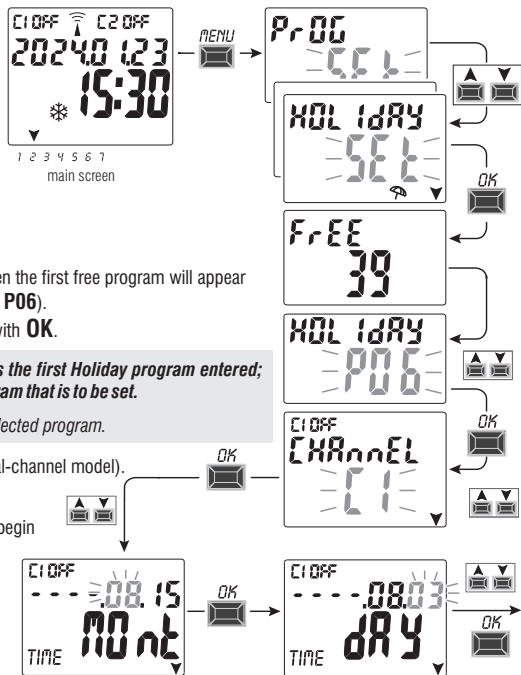

continue

- Use the ▲▼ keys to select the month when program suspension is to be terminated (ON) (the number of the month flashes). Confirm with **OK**.
- Use the ▲▼ keys to select the day when program suspension is to be terminated (ON) (the number of the day flashes). Confirm with **OK**.

Attention: if the dates set for OFF and ON are the same and **OK** is pressed, **Err** will appear on the display for a few seconds and then returns to step 3 (channel selection) and then enter the desired dates.

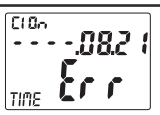

- After entering the program, the display first shows **OKAY** and immediately after the number of free programs left and then the last set program.
Set a new holiday program or press the **MENU** key twice to exit and return to the main screen.

*Note: if the set suspension end month (ON) is before the set suspension start month (OFF), the **HOLIDAY** program will start in the current year and will end the following year (useful function to save a program at the end of the year).*

When a Holiday program is active, the manual icon (of the relevant channel/s) flashes on the display together with the umbrella icon.

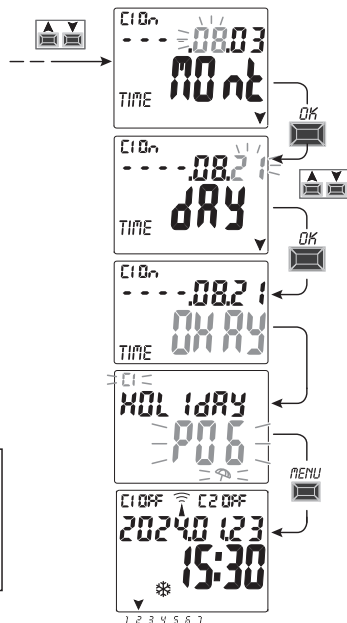
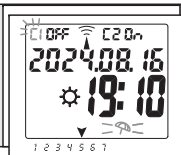

5.2) Visualizing or modifying a HOLIDAY program already saved

Enter the **HOLIDAY SET** menu as described in point 1 on the previous page, select the desired Holiday program with the ▲▼ keys and confirm with **OK**. Press the **OK** key consecutively for the settings to appear again and reconfirm them. Change a setting by using the ▲▼ keys and confirm with the **OK** key. View or edit all the settings until **OKAY** appears for a few seconds. Exit the **HOLIDAY SET** menu by pressing the **MENU** key.

6 - Deleting a program («ERASE PG» menu)

1. Press the **MENU** key to access the first menu (**PROG SET**).
2. Use the **▲▼** keys to select the **ERASE PG SET** menu.
Confirm with **OK**.
3. The display shows the **ERASE PG SING** screen to delete a single program or use the **▲▼** keys to select **ERASE PG ALL** to delete all the saved programs (including the **HOLIDAY** programs possibly saved).

4a. If **ERASE PG SING** is selected, confirm with **OK**.

Use the **▲▼** keys to select the program that is to be deleted.

Confirm with **OK**; the program will be deleted.

Another program can be deleted or press the **MENU** key 3 times to exit and view the main screen.

*Note: if the selected program that is to be deleted is a **HOLIDAY** program, the icon  will appear under the program number.*

- ### 4b. If you choose **ERASE PG ALL**, and confirm with **OK** all the programs will be deleted from the memory (the flashing icon indicates that attention must be paid because this operation will delete all the programs and will no longer be recoverable).

After a few seconds **OKAY** appears on the display and then the normal operation main screen.

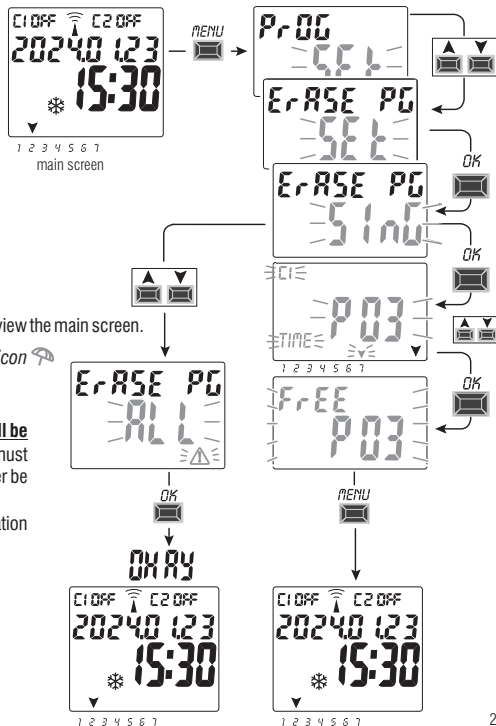

7 - «OVERRIDE» menu

This menu allows you to **manually force** the status of the outputs/s (dual-channel mod.) regardless of the active programs. Generally used to test or perform maintenance of the connected load.

Activating an override

1. Press the **MENU** key to access the first menu (**PROG SET**).
2. Use the **▲▼** keys to select the **OVERRIDE SET**. Confirm with **OK**.
3. Use the **▲▼** keys to select channel CH1 or CH2 (dual-channel mod.). Confirm with **OK**.
4. Use the **▲▼** keys to select the override mode (according to that indicated in the table). Confirm with **OK**. **OKAY** appears for a few seconds and then the display will show the selected setting.

5. **Disable the manual override** by setting channels

C1 and/or C2 (dual-channel mod.) to **AUTO**. Confirm with **OK**.

*Note: you can access directly from the main screen to the **OVERRIDE** menu of channel **CH1** by pressing simultaneously the **MENU+▲** and the **OVERRIDE** menu of channel **CH2** (dual-channel version) by pressing the **OK+▼** keys simultaneously.*

6. Exit and return to the home screen by pressing the **MENU** key three times.

Permanent manual override (PERM)

This mode has the highest priority. This allows you to manually override the status of the outputs (ON and OFF) **permanent** regardless of that required by the saved programs. Disable the manual override permanently by setting the channel/s to **AUTO**.

Temporary manual override (TEMP)

This mode has the highest priority. This allows you to manually override the status of the outputs (ON and OFF) **temporary** regardless of that required by the saved programs. The temporary manual override is automatically disabled when the first saved program intervenes or by setting the channel/s to **AUTO**.

Override mode	Display symbol	Channel-Condition	Override function
AUTO		C1 C2	No override on the channel, program-controlled
PERM	⚡	C1 On C2 On	Activated permanent channel
PERM	⚡	C1 OFF C2 OFF	Disabled permanent channel.
TEMP	⚡	C1 On C2 On	Activated channel until any program intervenes .
TEMP	⚡	C1 OFF C2 OFF	Channel disabled until any program intervenes .

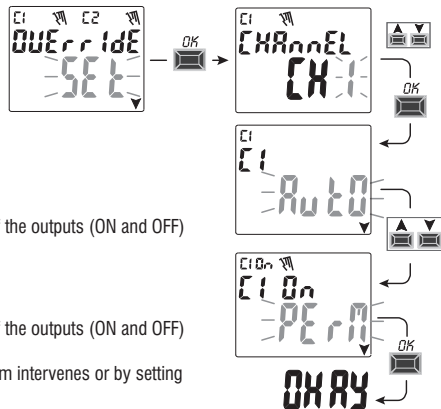

8 - «OPTION» menu

The following is possible from this menu:

- Language selection
- ASTRO / TIME setting
- Maintenance
- Hour counter
- LED light (backlighting)
- Warranty
- Info

1. Press the **MENU** key to access the first menu (**PROG SET**).
2. Use the **▲▼** keys to select the **OPTION SET**. Confirm with **OK**.
3. The sub-menu is accessed.

Proceed as described below according to the selected sub-menu.

8.1) CHANGING THE LANGUAGE

1. From the **LANGUAGE SET**, confirm with **OK**.
2. Use the **▲▼** keys to select the desired language from **IT -> EN -> DE -> FR -> ES**

Confirm with **OK**. **OKAY** appears on the display.

3. Exit and return to the main screen by pressing the **MENU** key twice.

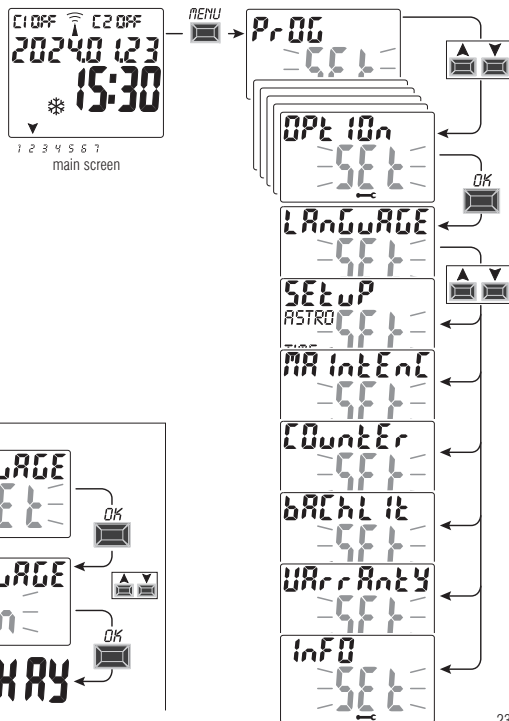

8.2) SETUP

1. From the **SETUP SET** sub-menu confirm with **OK**.
2. Use the **▲▼** keys to select between **ASTRO** and **TIME**. Confirm with **OK**.
3. If you select **ASTRO SET** you can activate/deactivate the astronomical function and enter and/or edit the coordinates. Proceed as described in paragraph 2. 1.
4. If you select **TIME SET** you can edit the data concerning: year, month, day, hour, minutes and summer or winter time (as described in chapter 2 - «First start-up»).
5. When you finish editing or viewing the data, confirm with **OK**, and **OKAY** appears on the display for a few seconds followed by the modified **ASTRO** or **TIME SET** settings.
6. Exit and return to the home screen by pressing the **MENU** key twice.

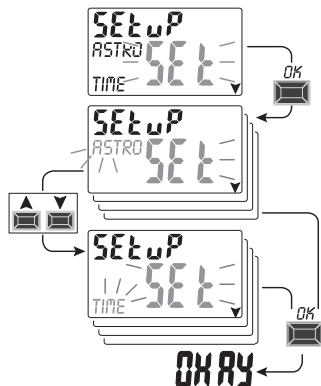

8.3) MAINTENANCE (MAINTENC)

This function allows you to set an ON operating period for each channel, after which the digital switch indicates that maintenance is required on the device connected to the relevant channel.

1. From the **MAINTENC SET** sub-menu confirm with **OK**.
2. Use the **▲▼** keys to select the desired channel from **CH1** or **CH2** (dual-channel model).
Confirm with **OK**.
3. Use the **▲▼** keys to set the maintenance frequency (in hours).
(press the **▲** key or **▼** pulse key to increase or decrease individually and keep pressed to increase or decrease in tens).
4. Confirm with **OK** and **OKAY** appears on the display for a few seconds.
5. Exit and return to the home screen by pressing the **MENU** key three times.

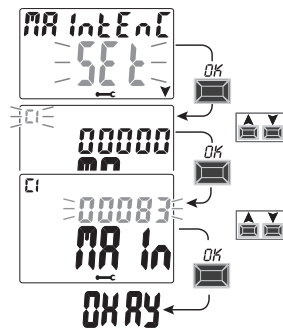

8.3.a) Managing a maintenance operation

- Once the operating hours set for one or both channels (dual-channel model) are reached, **MAINTEN** will appear on the main screen in cyclic repetition alternating with the current **DATE** (example in the figure at the side: channel 1 in Maintenance).
 - In this condition you can override the status of the outputs (from the MANUAL menu) and manage the maintenance intervention.
 - Eliminate the maintenance alert from the main screen by:
 - keeping the ▲ key pressed for 3 seconds to reset the alarm of channel C1,
 - keeping the ▼ key pressed for 3 seconds to reset the alarm of channel C2 (dual-channel model).
- This will reset the channel and the count of the hours set starts from the beginning.

Attention: when the **MAINTEN** text is deleted, the counter is automatically rebooted and the count starts again.

Attention: if you change the maintenance interval any partial count already taken will be lost.

Disabling the «Maintenance» function

In order not to use the **MAINTENANCE** function, set the counter to zero for channel C1 and/or C2 (dual-channel model).

8.4) HOUR COUNTER

This feature allows you to view and reset the count of operating hours in ON for channel 1 and/or channel 2 (dual-channel mod.). This is useful to monitor the life of the load/device connected to the channel.

1. From the **COUNTER SET** sub-menu confirm with **OK**.
2. Use the ▲▼ keys to select the desired channel from **CH1** or **CH2** (dual-channel model).
The operating hours of the selected channel will be displayed.

Reset the hour counter:

3. Use the ▲▼ keys to select the desired channel from **CH1** or **CH2** (dual-channel model).
4. **Press the key corresponding to the selected channel for 3 seconds** (the number of the hour flashes):
 - key ▲ for channel CH1
 - key ▼ for channel CH2 (only for the dual-channel model)
5. Press **OK**: **OKAY** appears on the display for a few seconds and the count is reset.
6. Exit and return to the home screen by pressing the **MENU** key three times.

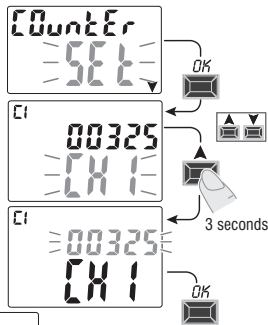
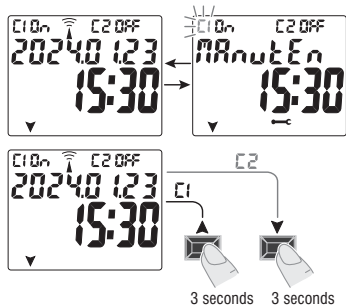

8.5) BACKLIGHTING

This function allows you to set the display backlighting in three modes:

- **Timed** = on for 6 seconds after a key is pressed.
- **Fixed ON** = always on (default)
- **Fixed OFF** = always off

1. From the **BACHLIT SET** sub-menu confirm with **OK**.
2. Use the **▲▼** keys to select the desired setting. Confirm with **OK**.
OKAY appears on the display for a few seconds.
3. Exit and return to the home screen by pressing the **MENU** key three times.

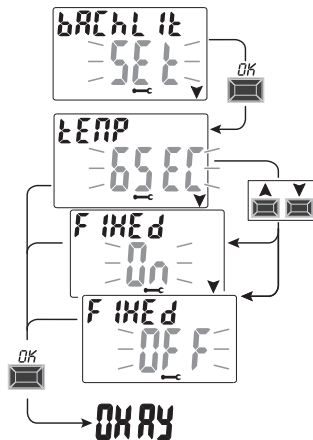

8.6) WARRANTY

This function allows the elapsed time (in days) to be displayed from when the product is commissioned.

This data is useful in terms of its warranty.

1. From the **UARRANTY SET** sub-menu confirm with **OK**.
2. The days elapsed since the product was commissioned are displayed.
3. Exit and return to the home screen by pressing the **MENU** key three times.

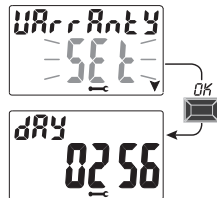

8.7) INFO

This feature allows you to view information about the version of software installed on the product.

1. From the **INFO SET** sub-menu confirm with **OK**.
2. Information about the version of software is displayed.
3. Exit and return to the home screen by pressing the **MENU** key three times .

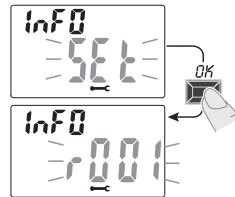



PERRY ELECTRIC Srl - Via Milanese, 11 - 22070 VENIANO (Como) ITALY

Recycling: PAPER. Check the regulations of your municipality

